



ITT

Residential Water Systems

Red Jacket Water Products

GRIZZLY



FEATURES

- Nylon impact and corrosion resistant discharge head and motor adapter.
- Pump shell constructed with a press and roll process for better performance.
- 303 stainless steel pump parts for maximum corrosion resistance.
- Powered by CentriPro (C) or Franklin Electric (F) submersible motors. Available in 2-wire and 3-wire single-phase and three-phase models.
- Noryl® Impeller-diffuser assemblies are mounted on a 16-spline 303 stainless steel shaft for positive drive.
- Noryl®-stage components (impellers/diffusers) are permanently bonded by a reliable, fool-proof, ultrasonic welding technique.



Red Jacket Water Products is a brand of ITT Water Technology, Inc. - a subsidiary of ITT Industries, Inc.

www.redjacketwaterproducts.com

Engineered for life

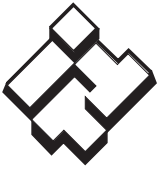

ITT

RED JACKET WATER PRODUCTS
Residential Water Systems

Grizzly Water End Lengths and Weights

Order Number	Required HP	Stages	Length (in.)	Weight (lbs.)
6G17	1/2	17	22.5	5
6G19	3/4	19	25.2	7
6G24	1	24	29.7	8
8G12	1/2	12	17.6	4
8G16	3/4	16	21.2	5
8G21	1	21	26.3	7
8G25	1 1/2	25	29.9	12
12G8	1/2	8	14.2	4
12G9	1/2	9	15.1	5
12G12	3/4	12	17.8	5
12G14	1	14	19.7	6
12G18	1 1/2	18	24.0	7
20G5	1/2	5	11.4	3
20G6	3/4	6	12.3	3
20G8	1	8	14.2	4
20G11	1 1/2	11	16.9	5
25G7	1	7	14.9	4
25G10	1 1/2	10	18.2	5

NOTE: To order a complete pump and motor assembly combine the motor order number followed by the pump water end order number. Complete numbers for models with a CentriPro motor or numbers for a model with a Franklin Electric motor differ only by a "C" or "F" in the motor code. The price book contains price lists for both versions.

EXAMPLE: a 50C3116G17 = a 1/2 HP, 230V, 3-wire CentriPro motor on a 6G17 water end. A 50F3116G17 is the same pump with an FE motor.

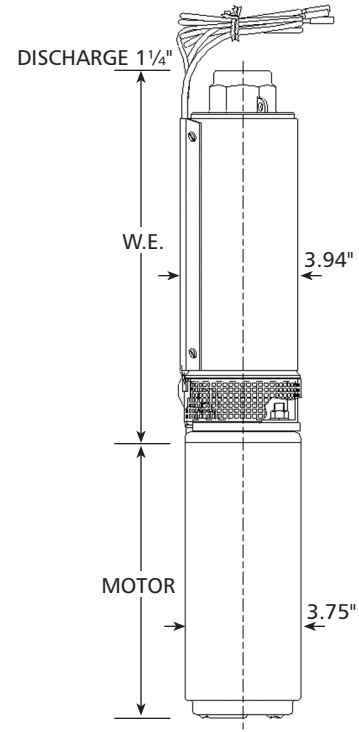

Water Pumps from Red Jacket are the natural choice of well drillers, pump installers and home owners alike. Built on over 120 years of engineering excellence, the name Red Jacket has become synonymous with quality for generations of customers who enjoy well water. The Grizzly submersible pump is no exception. Rugged and reliable, the Grizzly is designed to exceed performance requirements in the most demanding applications. Whether your needs are home, farm or industrial, choose the Red Jacket pump generations have come to count on.

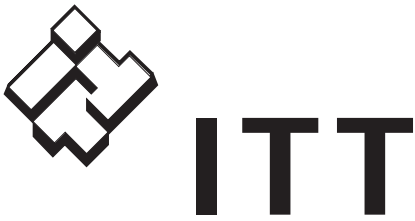

RED JACKET WATER PRODUCTS Residential Water Systems

CENTRIPRO 4" SINGLE-PHASE MOTORS

Red Jacket No.	Type	HP	Volts	Length (in)	Weight (lb)
50C201	2-wire PSC	.5	115	11.0	19.2
50C211		.5	230	11.0	19.2
75C211		.75	230	12.4	22.7
100C211		1	230	13.3	24.5
150C211		1.5	230	14.9	28.9
50C301	3-wire	.5	115	10.0	18.9
50C311		.5	230	9.7	18.1
75C311		.75	230	10.8	21.4
100C311		1	230	11.7	23.1
150C311		1.5	230	13.6	27.4

FRANKLIN ELECTRIC 4" SINGLE-PHASE MOTORS

Red Jacket No.	Type	HP	Volts	Length (in)	Weight (lb)
50F201	2-wire Split- Phase	.5	115	9.5	18
50F211		.5	230	9.5	18
75F211		.75	230	10.7	21
100F211		1	230	11.8	24
150F211		1.5	230	15.1	31
50F301	3-wire	.5	115	9.5	19
50F311		.5	230	9.5	19
75F311		.75	230	10.7	21
100F311		1	230	11.8	24
150F311		1.5	230	13.6	28

FRANKLIN ELECTRIC 4" THREE-PHASE MOTORS

Red Jacket No.	HP	Volts	Length (in)	Weight (lb)
50F323	.5	200	9.5	18
50F313		230		
50F353		460		
75F323	.75	200	10.7	21
75F313		230		
75F353		460		
100F323	1	200	11.8	24
100F313		230		
100F353		460		
150F323	1.5	200	11.8	24
150F313		230		
150F353		460		
150F363		575		

NEMA MOTOR

- Corrosion resistant stainless steel construction.
- Built-in surge arrestor is provided on single phase motors through 5 HP.
- Stainless steel splined shaft.
- Hermetically sealed windings.
- Replaceable motor lead assembly.
- UL 778 recognized.
- NEMA mounting dimensions.
- Control box is required with 3 wire single phase units.
- Three phase units require a magnetic starter with three leg protection. Magnetic starter and heaters must be ordered separately.



ITT

RED JACKET WATER PRODUCTS Residential Water Systems

1/2 HP Grizzly Submersible Pumps – Available in 2- and 3-Wire

Motor	1/2 HP					1/2 HP					1/2 HP					1/2 HP					1/2 HP				
Pump End	6G17					8G12					12G8					12G9					20G5				
Discharge Pressure	20#	30#	40#	50#	60#	20#	30#	40#	50#	60#	20#	30#	40#	50#	60#	20#	30#	40#	50#	60#	20#	30#	40#	50#	60#
0																									
20			7.8	7.4	7.0		10.1	9.6	9.0	8.6	13.9	13.2	12.4	11.5	10.2	14.1	13.7	13.1	12.1	10.9	21.6	19.5	16.8	13.6	7.4
40		7.9	7.5	7.0	6.6	10.1	9.7	9.1	8.6	8.2	13.3	12.5	11.6	10.4	8.8	13.8	13.2	12.3	11.1	9.8	19.8	17.2	14.1	8.7	
60		7.5	7.1	6.7	6.2	9.8	9.2	8.7	8.3	7.7	12.6	11.7	10.6	9.0	7.3	13.3	12.4	11.3	10.0	8.7	17.5	14.6	9.8		
80		7.2	6.7	6.3	5.8	9.2	8.7	8.3	7.8	7.1	11.9	10.7	9.2	7.6	5.5	12.5	11.4	10.1	8.9	7.5	15.0	10.7			
100	7.2	6.8	6.3	5.7	5.4	8.8	8.4	7.9	7.2	6.3	10.9	9.4	7.8	5.9		11.6	10.3	9.0	7.7	5.8	11.5				
120	6.8	6.4	6.0	5.5	5.0	8.4	8.0	7.3	6.4	5.3	9.6	8.0	6.2			10.5	9.2	7.9	6.1	2.7					
140	6.5	6.0	5.5	5.0	4.5	8.1	7.4	6.5	5.6	4.7	8.2	6.5	3.1			9.4	8.1	6.4	3.4						
160	6.1	5.6	5.1	4.6	4.0	7.5	6.7	5.7	4.8	3.6	6.8	3.8				8.2	6.7	3.9							
180	5.7	5.2	4.7	4.1	3.4	6.8	5.9	4.9	3.8		4.4					6.9	4.4								
200	5.3	4.7	4.2	3.5	2.8	6.0	5.1	4.0	1.8						4.9										
220	4.8	4.2	3.6	2.9	2.0	5.2	4.2	2.3																	
240	4.3	3.7	3.0	2.1	1.2	4.3	2.6																		
260	3.8	3.1	2.3	1.3		3.0																			
280	3.2	2.4	1.5																						
300	2.5	1.0																							
320	1.7																								
340																									
360																									
380																									
400																									
420																									
440																									
460																									
480																									
500																									
520																									
540																									
560																									
580																									
600																									
620																									
640																									
660																									
680																									
700																									
720																									
740																									
Shutoff PSI	175					143					104					115					71				
Best Efficiency	5 GPM					7 GPM					10 GPM					10 GPM					18 GPM				



ITT

RED JACKET WATER PRODUCTS Residential Water Systems

3/4 HP Grizzly Submersible Pumps – Available in 2- and 3-Wire

Motor	3/4 HP					3/4 HP					3/4 HP					3/4 HP									
Pump End	6G19					8G16					12G12					20G6									
Discharge Pressure	20#	30#	40#	50#	60#	20#	30#	40#	50#	60#	20#	30#	40#	50#	60#	20#	30#	40#	50#	60#	20#	30#	40#	50#	60#
0																									
20					7.4	9.9	9.6	9.4	9.2	9.1		14.0	13.7	13.4	12.9	23.2	21.6	19.4	17.1	14.6					
40				7.5	7.1	9.6	9.4	9.3	9.1	8.9	14.0	13.8	13.4	13.0	12.3	21.8	19.7	17.5	15.0	11.1					
60			7.5	7.2	6.8	9.4	9.3	9.1	8.9	8.7	13.8	13.5	13.0	12.4	11.6	20.0	17.8	15.3	11.8	4.1					
80			7.2	6.8	6.4	9.3	9.1	9.0	8.7	8.4	13.5	13.1	12.5	11.7	10.8	18.1	15.7	12.4	5.5						
100		7.3	6.9	6.5	6.0	9.2	9.0	8.8	8.4	8.0	13.2	12.6	11.8	11.0	10.0	16.0	13.0	6.8							
120	7.3	6.9	6.5	6.1	5.7	9.0	8.8	8.5	8.1	7.6	12.7	11.9	11.1	10.2	9.3	13.5	8.0								
140	7.0	6.6	6.2	5.7	5.3	8.8	8.5	8.1	7.7	7.1	12.0	11.2	10.3	9.4	8.5	9.0									
160	6.6	6.2	5.8	5.3	4.9	8.6	8.2	7.7	7.2	6.6	11.3	10.4	9.5	8.6	7.6										
180	6.3	5.8	5.4	4.9	4.4	8.3	7.8	7.3	6.7	6.1	10.5	9.6	8.7	7.8	6.5										
200	5.9	5.5	5.0	4.5	4.0	7.9	7.3	6.8	6.2	5.5	9.7	8.8	7.9	6.7	4.6										
220	5.5	5.1	4.6	4.1	3.5	7.4	6.8	6.2	5.6	5.0	9.0	8.0	6.9	5.0											
240	5.1	4.6	4.1	3.6	2.9	6.9	6.3	5.7	5.1	4.3	8.2	7.1	5.3												
260	4.7	4.2	3.7	3.0	2.3	6.4	5.8	5.1	4.4	3.3	7.2	5.6													
280	4.3	3.7	3.1	2.4	1.6	5.9	5.2	4.5	3.5	1.9	5.9	3.2													
300	3.8	3.2	2.5	1.8		5.3	4.6	3.7	2.2		3.6														
320	3.3	2.6	1.9			4.7	3.8	2.4																	
340	2.7	2.0				4.0	2.6																		
360	2.1	1.2				2.9																			
380	1.3																								
400																									
420																									
440																									
460																									
480																									
500																									
520																									
540																									
560																									
580																									
600																									
620																									
640																									
660																									
680																									
700																									
720																									
740																									
Shutoff PSI	198					188					156					87									
Best Efficiency	5 GPM					7 GPM					10 GPM					18 GPM									

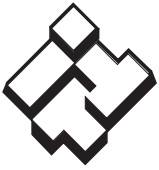

ITT

RED JACKET WATER PRODUCTS Residential Water Systems

1 HP Grizzly Submersible Pumps – Available in 2- and 3-Wire

Motor	1 HP					1 HP					1 HP					1 HP					1 HP				
Pump End	6G24					8G21					12G14					20G8					25G7				
Discharge Pressure	20#	30#	40#	50#	60#	20#	30#	40#	50#	60#	20#	30#	40#	50#	60#	20#	30#	40#	50#	60#	20#	30#	40#	50#	60#
0																									
20									9.9	9.6				14.0	13.7	24.5	23.5	22.1	20.6	19.2	30.5	29.4	27.5	23.8	19.6
40								9.9	9.6	9.4			14.0	13.7	13.3	23.6	22.3	20.8	19.4	18.0	29.6	27.9	24.4	20.1	16.7
60							10.0	9.7	9.4	9.2			13.8	13.4	12.8	22.5	22.0	19.5	18.2	16.6	28.2	25.0	20.7	17.1	13.1
80					7.4	10.0	9.7	9.4	9.2	9.0		13.8	13.4	12.9	12.3	21.2	19.7	18.4	16.8	14.5	25.5	21.2	17.5	13.9	
100				7.4	7.1	9.8	9.5	9.2	9.0	8.8	13.9	13.5	13.0	12.4	11.7	19.9	18.6	17.1	14.9	11.4	21.8	17.9	14.6		
120			7.4	7.2	6.9	9.5	9.3	9.0	8.8	8.5	13.5	13.1	12.5	11.8	11.0	18.7	17.3	13.2	11.9	7.2	18.4	15.1	6.9		
140		7.5	7.2	6.9	6.6	9.3	9.0	8.8	8.6	8.3	13.1	12.6	11.9	11.1	10.3	17.5	15.6	12.5	7.9		15.6	8.8			
160	7.5	7.2	6.9	6.6	6.3	9.1	8.8	8.6	8.3	8.0	12.6	12.0	11.2	10.4	9.6	15.9	13.0	8.6			10.4				
180	7.3	7.0	6.7	6.4	6.0	8.9	8.6	8.4	8.1	7.7	12.1	11.3	10.5	9.7	8.9	13.4	9.3								
200	7.0	6.7	6.4	6.1	5.7	8.7	8.4	8.1	7.7	7.3	11.4	10.6	9.8	9.0	8.2	9.9									
220	6.8	6.5	6.1	5.8	5.4	8.5	8.1	7.8	7.3	6.9	10.7	9.9	9.1	8.3	7.3	5.4									
240	6.5	6.2	5.8	5.4	5.0	8.2	7.8	7.4	6.9	6.4	10.0	9.2	8.4	7.5	6.1										
260	6.2	5.9	5.5	5.1	4.7	7.9	7.5	7.0	6.5	6.0	9.3	8.5	7.6	6.3	4.3										
280	5.9	5.5	5.1	4.7	4.3	7.5	7.1	6.6	6.1	5.6	8.7	7.8	6.5	4.6											
300	5.6	5.2	4.8	4.3	3.9	7.1	6.6	6.1	5.5	5.2	7.9	6.7	4.9												
320	5.3	4.8	4.4	3.9	3.5	6.7	6.2	5.7	5.2	4.8	6.9	5.2													
340	4.9	4.5	4.0	3.5	3.0	6.3	5.8	5.3	4.8	4.3	5.5	2.9													
360	4.5	4.1	3.6	3.1	2.5	5.8	5.4	4.9	4.4	3.7	3.3														
380	4.1	3.7	3.1	2.6	2.0	5.4	4.9	4.5	3.8	3.0															
400	3.7	3.2	2.7	2.1	1.3	5.0	4.5	3.9	3.1	1.7															
420	3.3	2.7	2.1	1.4		4.6	4.0	3.2	2.0																
440	2.8	2.2	1.5			4.1	3.4	2.2																	
460	2.3	1.6				3.5	2.4																		
480	1.7					2.6																			
500																									
520																									
540																									
560																									
580																									
600																									
620																									
640																									
660																									
680																									
700																									
720																									
740																									
Shutoff PSI	248					242					182					117					95				
Best Efficiency	5 GPM					7 GPM					10 GPM					18 GPM					22 GPM				



ITT

RED JACKET WATER PRODUCTS Residential Water Systems

1 1/2 HP Grizzly Submersible Pumps – Available in 2- and 3-Wire

Motor	1 1/2 HP					1 1/2 HP					1 1/2 HP					1 1/2 HP														
Pump End	8G25					12G18					20G11					25G10														
Discharge Pressure	20#	30#	40#	50#	60#	20#	30#	40#	50#	60#	20#	30#	40#	50#	60#	20#	30#	40#	50#	60#	20#	30#	40#	50#	60#	20#	30#	40#	50#	60#
0																														
20										13.9	24.5	23.9	23.5	22.8	21.8		30.1	29.3	28.2	26.3										
40										13.9	13.7	24.0	23.6	22.9	21.9	20.8	30.2	29.5	28.4	26.6	24.0									
60										14.0	13.8	13.5	23.6	23.0	22.1	20.9	19.8	29.6	28.6	26.9	24.4	21.5								
80					10.0			14.0	13.8	13.6	13.1	23.1	22.2	21.1	19.9	18.8	28.7	27.1	24.8	21.9	19.0									
100				10.0	10.1	14.0	13.8	13.6	13.3	13.0	22.3	21.3	20.1	19.0	17.9	27.4	28.1	22.3	19.4	16.9										
120				10.1	9.8	13.8	13.6	13.4	13.1	12.7	21.4	20.2	19.1	18.1	17.0	25.5	22.7	19.8	17.2	14.7										
140			10.1	9.9	9.4	13.7	13.4	13.1	12.7	12.3	20.4	19.3	18.2	17.1	15.7	23.1	20.2	17.5	15.1	11.6										
160		10.1	9.9	9.5	9.0	13.4	13.2	12.8	12.3	11.8	19.4	18.4	17.3	15.9	14.0	20.6	17.8	15.4	12.2											
180	10.1	10.0	9.6	9.1	8.7	13.2	12.8	12.4	11.9	11.3	18.5	17.4	16.1	14.3	11.6	18.2	15.8	12.8	6.4											
200	10.0	9.6	9.2	8.7	8.4	12.9	12.5	12.0	11.4	10.8	17.6	16.3	14.6	12.0	8.5	16.1	18.3	7.6												
220	9.7	9.2	8.8	8.5	8.2	10.5	12.0	11.5	10.9	10.2	16.5	14.9	12.4	9.0	4.7	13.8	8.7													
240	9.3	8.8	8.5	8.2	8.0	12.1	10.5	10.9	10.3	9.7	15.1	12.8	9.5	5.3		9.7														
260	8.9	8.5	8.3	8.0	7.8	11.6	11.0	10.4	9.8	9.2	13.2	10.0	5.9																	
280	8.6	8.3	8.1	7.9	7.6	11.1	10.5	9.9	9.2	8.6	10.5	6.5																		
300	8.3	8.1	7.9	7.6	7.3	10.6	9.9	9.3	8.7	8.1	7.1	2.6																		
320	8.1	7.9	7.7	7.4	7.0	10.0	9.4	8.8	8.2	7.5	3.2																			
340	7.9	7.7	7.4	7.1	6.6	9.5	8.9	8.3	7.6	6.7																				
360	7.7	7.5	7.1	6.7	6.2	9.0	8.3	7.7	6.8	5.6																				
380	7.5	7.2	6.8	6.3	5.8	8.4	7.8	7.0	5.8	4.0																				
400	7.2	6.8	6.4	5.9	5.4	7.9	7.1	6.0	4.3																					
420	6.9	6.4	6.0	5.5	5.1	7.2	6.1	4.5																						
440	6.5	6.0	5.6	5.1	4.7	6.3	4.8																							
460	6.1	5.6	5.2	4.8	4.4	5.0																								
480	5.7	5.2	4.8	4.5	4.0																									
500	5.3	4.9	4.5	4.1	3.3																									
520	4.9	4.6	4.1	3.5	2.2																									
540	4.6	4.2	3.6	2.4																										
560	4.3	3.7	2.6																											
580	3.8	2.8																												
600	3.0																													
620																														
640																														
660																														
680																														
700																														
720																														
740																														
Shutoff PSI	294					236					158					133														
Best Efficiency	7 GPM					10 GPM					18 GPM					22 GPM														

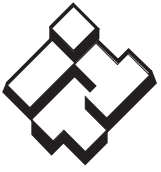

ITT

RED JACKET WATER PRODUCTS Residential Water Systems

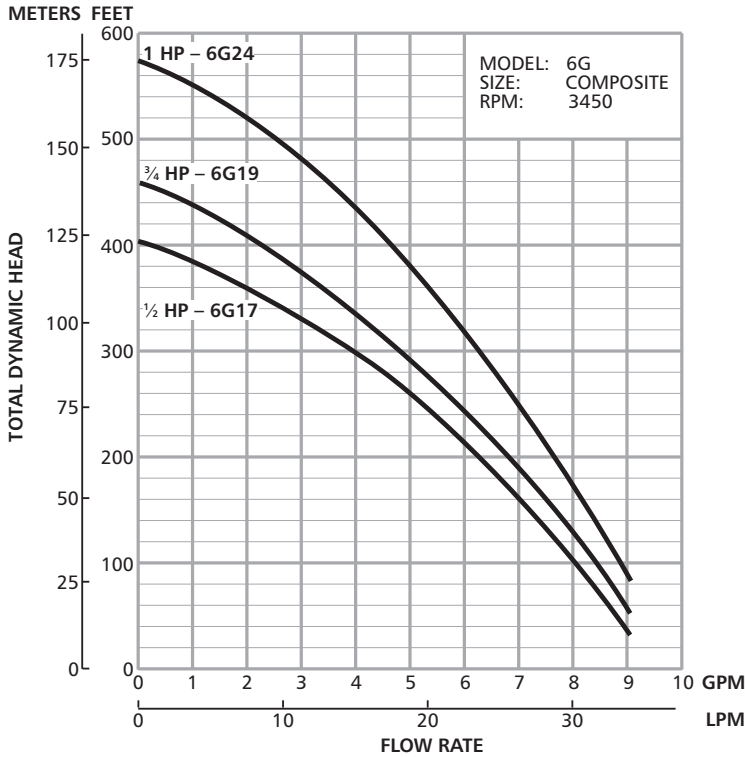

Performance Curves — 6G Series

Notes:

Model 6G, 3450 RPM.

Available in 2-wire and 3-wire models.

Guaranteed as minimum performance only if certified.

Minimum well size is 4-inch inside diameter.

Best efficiency can be reached at 5 GPM.

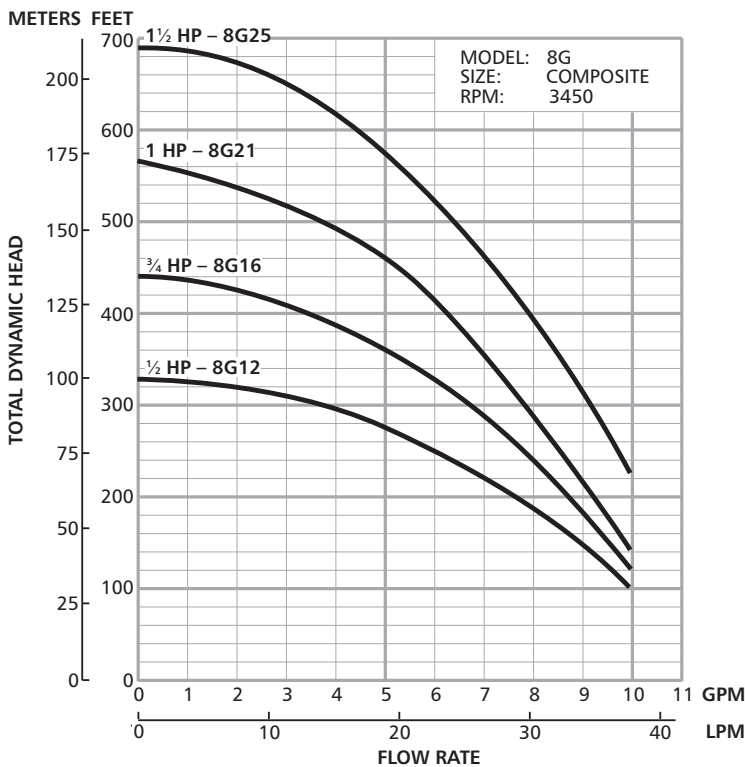

Performance Curves — 8G Series

Notes:

Model 8G, 3450 RPM.

Available in 2-wire and 3-wire models.

Guaranteed as minimum performance only if certified.

Minimum well size is 4-inch inside diameter.

Best efficiency can be reached at 7 GPM.

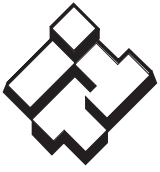

ITT

RED JACKET WATER PRODUCTS Residential Water Systems

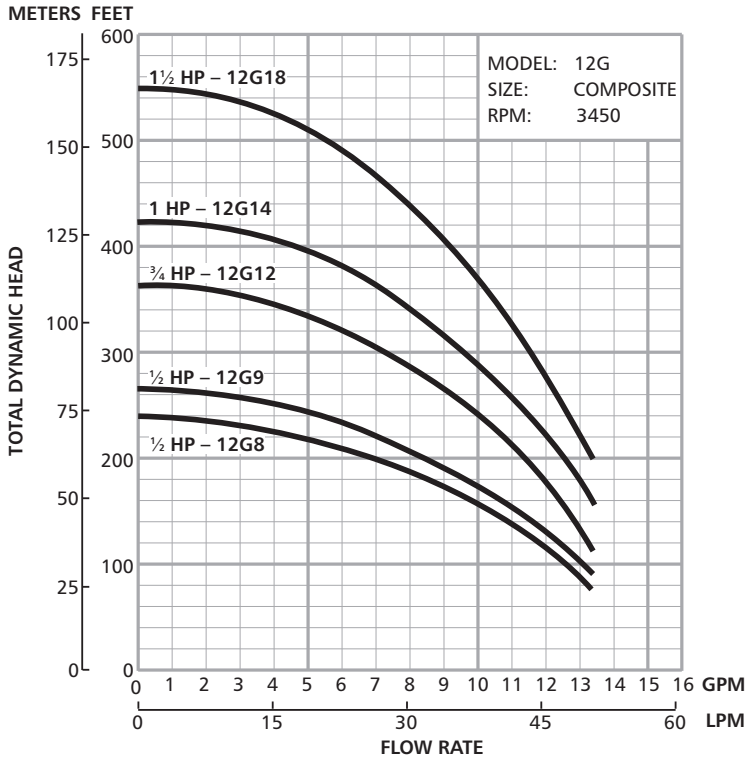

Performance Curves — 12G Series

Notes:

Model 12G, 3450 RPM.

Available in 2-wire and 3-wire models.

Guaranteed as minimum performance only if certified.

Minimum well size is 4-inch inside diameter.

Best efficiency can be reached at 10 GPM.

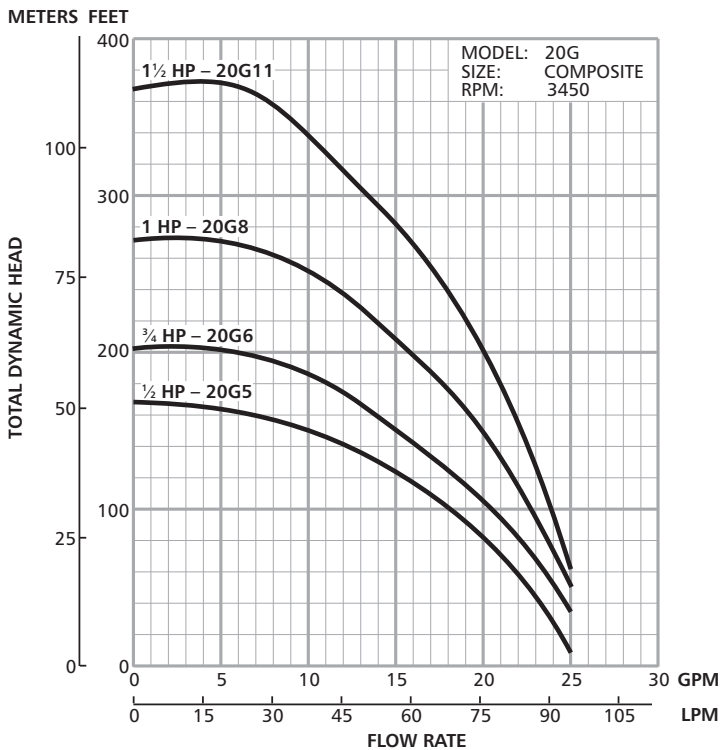

Performance Curves — 20G Series

Notes:

Model 20G, 3450 RPM.

Available in 2-wire and 3-wire models.

Guaranteed as minimum performance only if certified.

Minimum well size is 4-inch inside diameter.

Best efficiency can be reached at 18 GPM.



ITT

RED JACKET WATER PRODUCTS Residential Water Systems

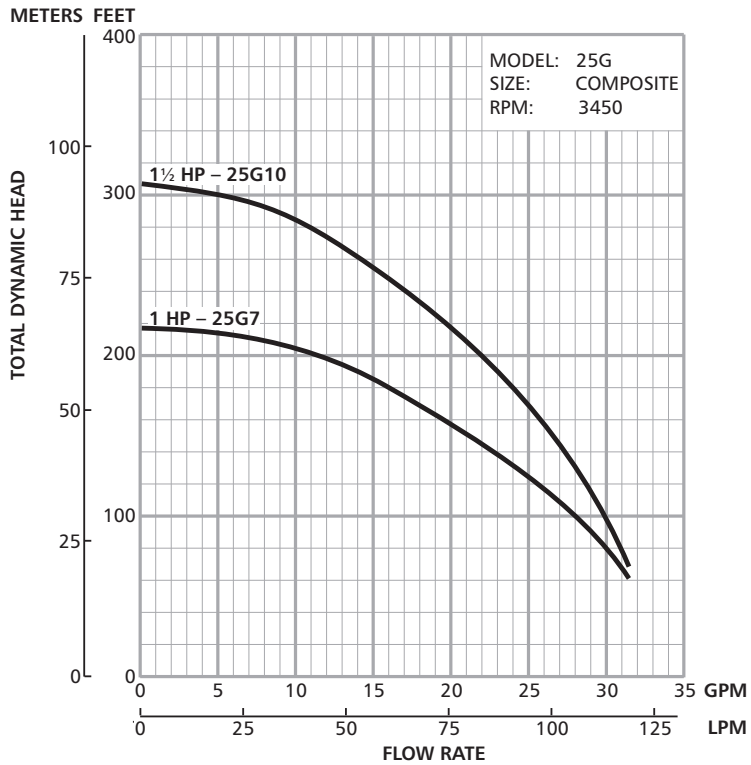

Performance Curves — 25G Series

Notes:

Model 25G, 3450 RPM.

Available in 2-wire and 3-wire models.

Guaranteed as minimum performance only if certified.

Minimum well size is 4-inch inside diameter.

Best efficiency can be reached at 22 GPM.

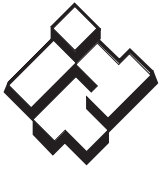

ITT

RED JACKET WATER PRODUCTS
Residential Water Systems



ITT

Residential Water Systems



Red Jacket Water Products is a licensed trademark. The ITT Engineered Blocks Symbol are registered trademarks and tradenames of ITT Industries, Inc.

Noryl is a registered trademark of GE Plastic.

SPECIFICATIONS ARE SUBJECT TO CHANGE WITHOUT NOTICE.

BRJGRIZZ March, 2006

© 2006 ITT Water Technology, Inc.

Engineered for life