

Position	Count	Description	Unit price
	1	<p><b>6 SQF-2</b></p>  <p>Product photo could vary from the actual product</p> <p>Product No.: 95027334 The 3" SQF pump with helical rotor is for high heads and low flows.</p> <p><b>Features and benefits:</b></p> <ul style="list-style-type: none"> <li>-Dry-running protection</li> <li>-High efficiency permanent-magnet motor (PM motor)</li> <li>-Over- and undervoltage protection</li> <li>-Overload protection</li> <li>-Maximum Power Point Tracking (MPPT)</li> <li>-Wide voltage range</li> </ul> <p><b>Liquid:</b></p> <p>Maximum liquid temperature: 104 °F Liquid temp: 68 °F Density: 62.29 lb/ft³</p> <p><b>Technical:</b></p> <p>Approvals on motor nameplate: CE Approvals on pump nameplate: CE, CTIC</p> <p><b>Materials:</b></p> <p>Pump: Stainless steel DIN W.-Nr. 1.4301 AISI 304</p> <p>Impeller: DIN W.-Nr. 1.4301</p> <p><b>Installation:</b></p> <p>Maximum ambient pressure: 218 psi Pump outlet: 1 NPT" Minimum borehole diameter: 2.99 in \:</p> <p><b>Electrical data:</b></p> <p>Motor type: MSF3 Power input - P1: 1.4 kW Rated voltage AC: 1 x 90-240 V Rated voltage DC: 30-300 V</p>	On request



**Company name:** Worldwide Power and Pump Services, Inc.

**Created by:** -

**Phone:** 866-960-9621

**Fax:** 866-960-9621

**Date:** 8-12-09

<i>Position</i>	<i>Count</i>	<i>Description</i>	<i>Unit price</i>
		Start. method: direct-on-line Rated current: 8.4 A Power factor: 1 Rated speed: 500-3600 rpm Enclosure class (IEC 34-5): 68 Insulation class (IEC 85): F Length of cable: 6.562 ft  <b>Others:</b> Net weight: 17.4 lb Gross weight: 21.4 lb Shipping volume: 0.85 ft <sup>3</sup>	



Company name: Worldwide Power and Pump Services, Inc.

Created by: -

Phone: 866-960-9621

Fax: 866-960-9621

Date: 8-12-09

### 95027334 6 SQF-2 60 Hz

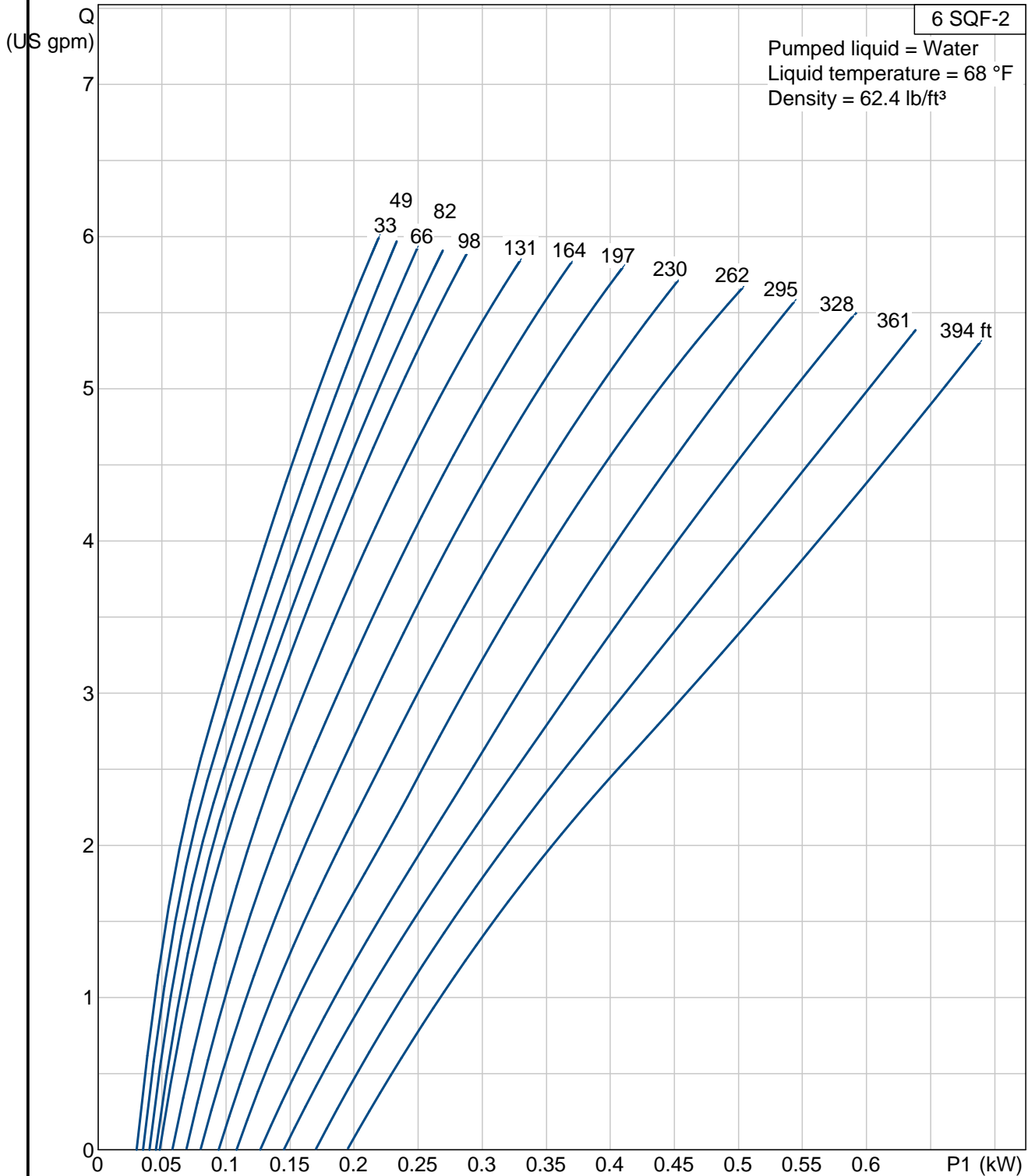

Description	Value
Product name:	6 SQF-2
Product No.:	95027334
EAN:	5700834791796
Technical:	
Approvals on motor nameplate:	CE
Approvals on pump nameplate:	CE, CTIC
Pump Number:	95027413
Stages:	2
Valve:	pump with built-in non-return valve
Materials:	
Pump:	Stainless steel DIN W.-Nr. 1.4301 AISI 304
Impeller:	DIN W.-Nr. 1.4301
Rotor:	Stainless steel DIN W.-Nr. 1.4301 AISI 304
Stator:	Stainless steel / EPDM DIN W.-Nr. 1.4301 AISI 304
Installation:	
Maximum ambient pressure:	218 psi
Pump outlet:	1 NPT"
Minimum borehole diameter:	2.99 in
Liquid:	
Maximum liquid temperature:	104 °F
Liquid temp:	68 °F
Density:	62.29 lb/ft <sup>3</sup>
Electrical data:	
Motor type:	MSF3
Power input - P1:	1.4 kW
Rated voltage AC:	1 x 90-240 V
Rated voltage DC:	30-300 V
Start. method:	direct-on-line
Rated current:	8.4 A
Power factor:	1
Rated speed:	500-3600 rpm
Enclosure class (IEC 34-5):	68
Insulation class (IEC 85):	F
Motor protection:	Y
Thermal protec:	internal
Length of cable:	6.562 ft
Motor Number:	96275336
Others:	
Net weight:	17.4 lb
Gross weight:	21.4 lb
Shipping volume:	0.85 ft <sup>3</sup>
Sales region:	N-amreg

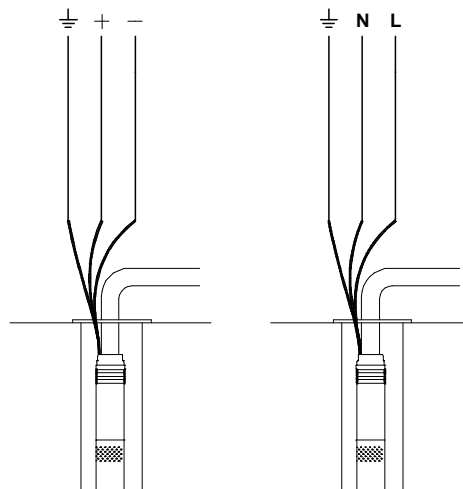
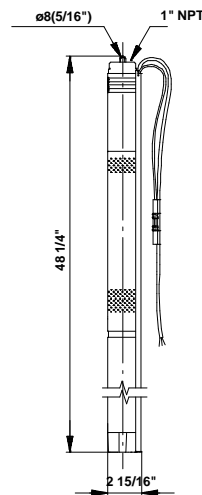
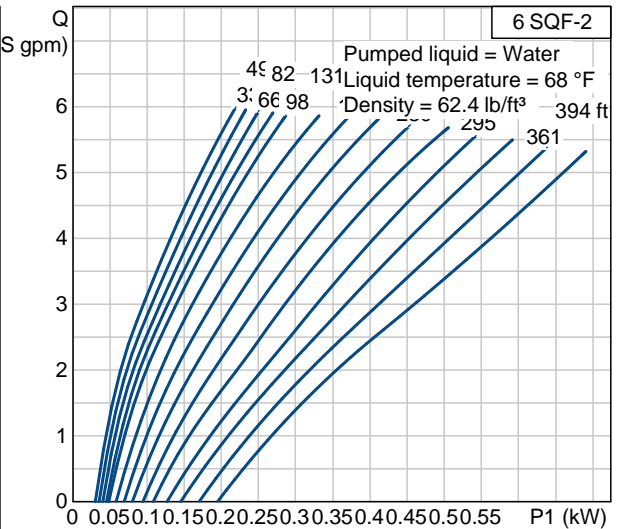

95027334 6 SQF-2 60 Hz

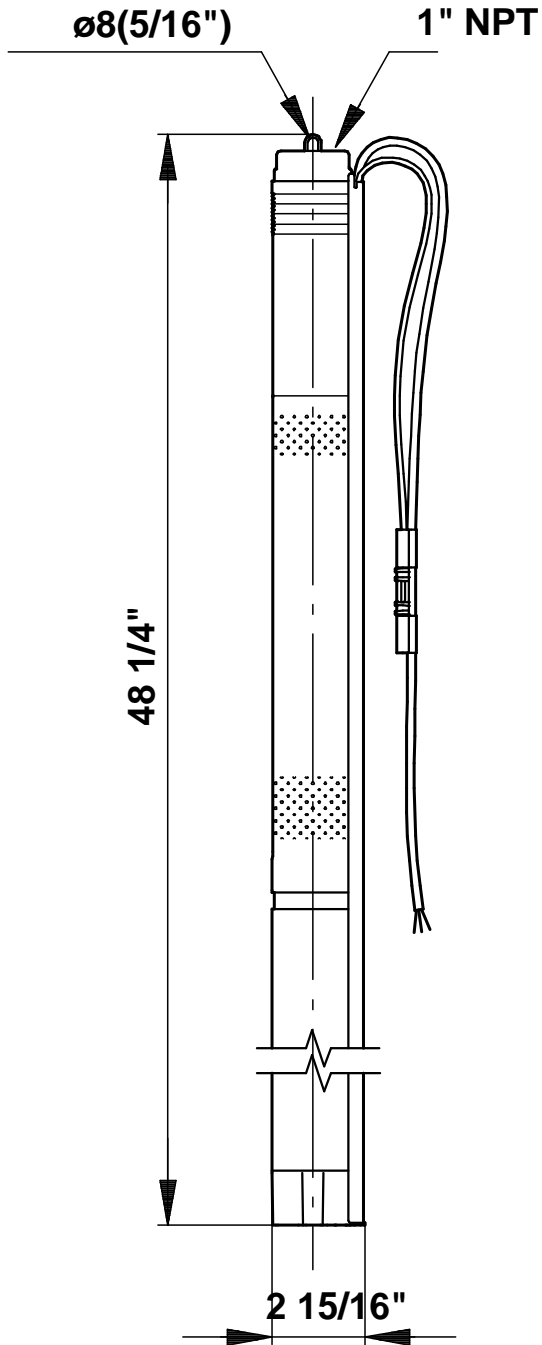

Note! All units are in [mm] unless others are stated.  
Disclaimer: This simplified dimensional drawing does not show all details.

**95027334 6 SQF-2 60 Hz**

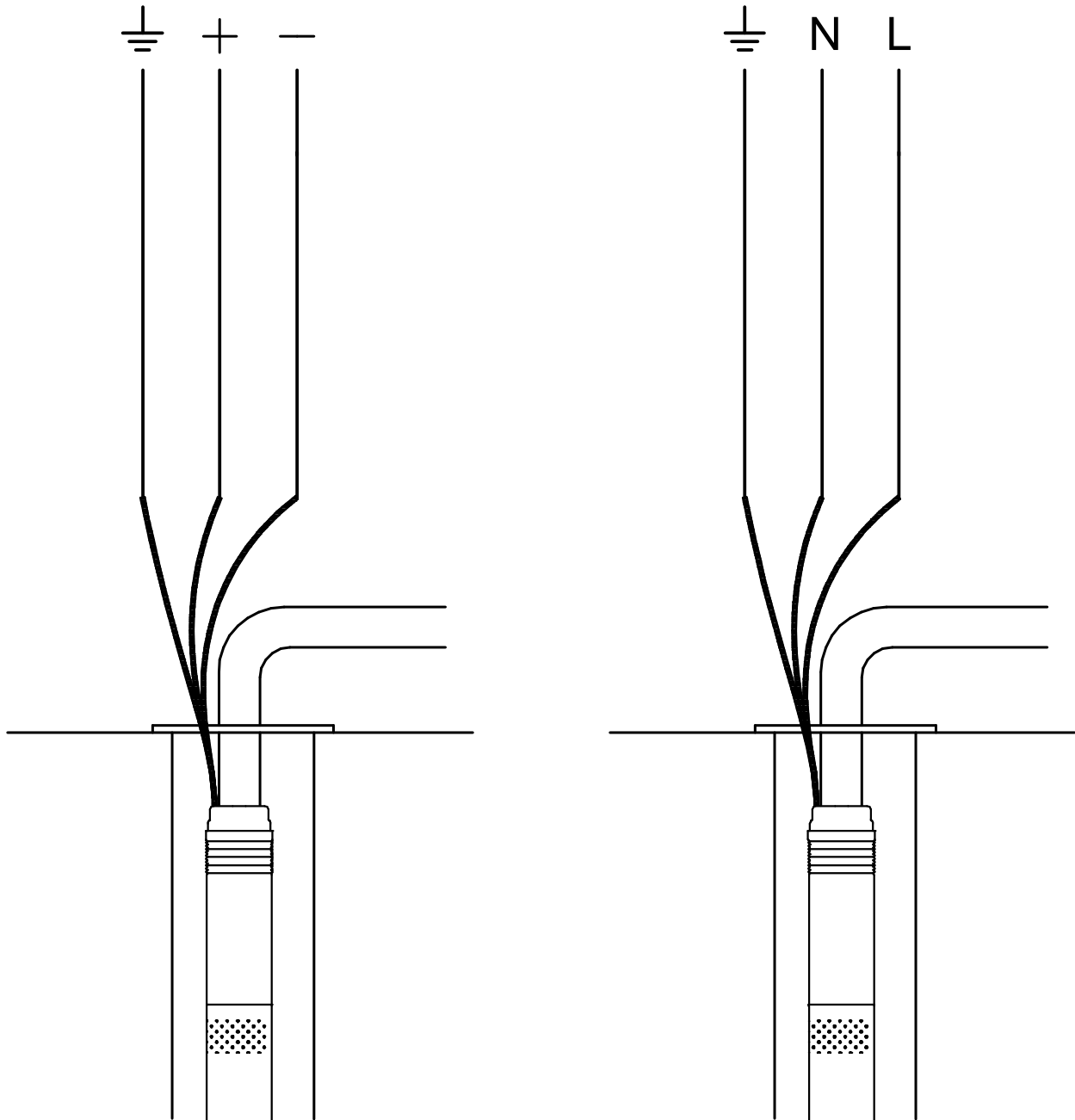

All units are [mm] unless otherwise presented.