

Position	Count	Description	Unit price
	1	<p>60 SQF-3</p>  <p>Product photo could vary from the actual product</p> <p>Product No.: 95027443</p> <p>The 4" SQF centrifugal pump is for low heads and large flows.</p> <p>Features and benefits:</p> <ul style="list-style-type: none"> -Dry-running protection -High efficiency permanent-magnet motor (PM motor) -Over- and undervoltage protection -Overload protection -Maximum Power Point Tracking (MPPT) -Wide voltage range <p>Liquid:</p> <p>Maximum liquid temperature: 104 °F Liquid temp: 68 °F Density: 62.29 lb/ft³</p> <p>Technical:</p> <p>Approvals on motor nameplate: CE</p> <p>Materials:</p> <p>Pump: Stainless steel DIN W.-Nr. 1.4301 AISI 304</p> <p>Impeller: Stainless steel DIN W.-Nr. 1.4301 AISI 304</p> <p>Installation:</p> <p>Maximum ambient pressure: 218 psi Pump outlet: 2 NPT" Minimum borehole diameter: 4.02 in \:</p> <p>Electrical data:</p>	On request



Company name: Worldwide Power and Pump Services, Inc.

Created by: -

Phone: 866-960-9621

Fax: 866-960-9621

Date: 8-12-09

Position	Count	Description	Unit price
		Motor type: MSF3 Power input - P1: 1.4 kW Rated voltage AC: 1 x 90-240 V Rated voltage DC: 30-300 V Start. method: direct-on-line Rated current: 8.4 A Power factor: 1 Rated speed: 500-3600 rpm Enclosure class (IEC 34-5): 68 Insulation class (IEC 85): F Length of cable: 6.562 ft Others: Net weight: 24 lb Gross weight: 27.3 lb Shipping volume: 1 ft ³	



Company name: Worldwide Power and Pump Services, Inc.

Created by: -

Phone: 866-960-9621

Fax: 866-960-9621

Date: 8-12-09

95027443 60 SQF-3 60 Hz

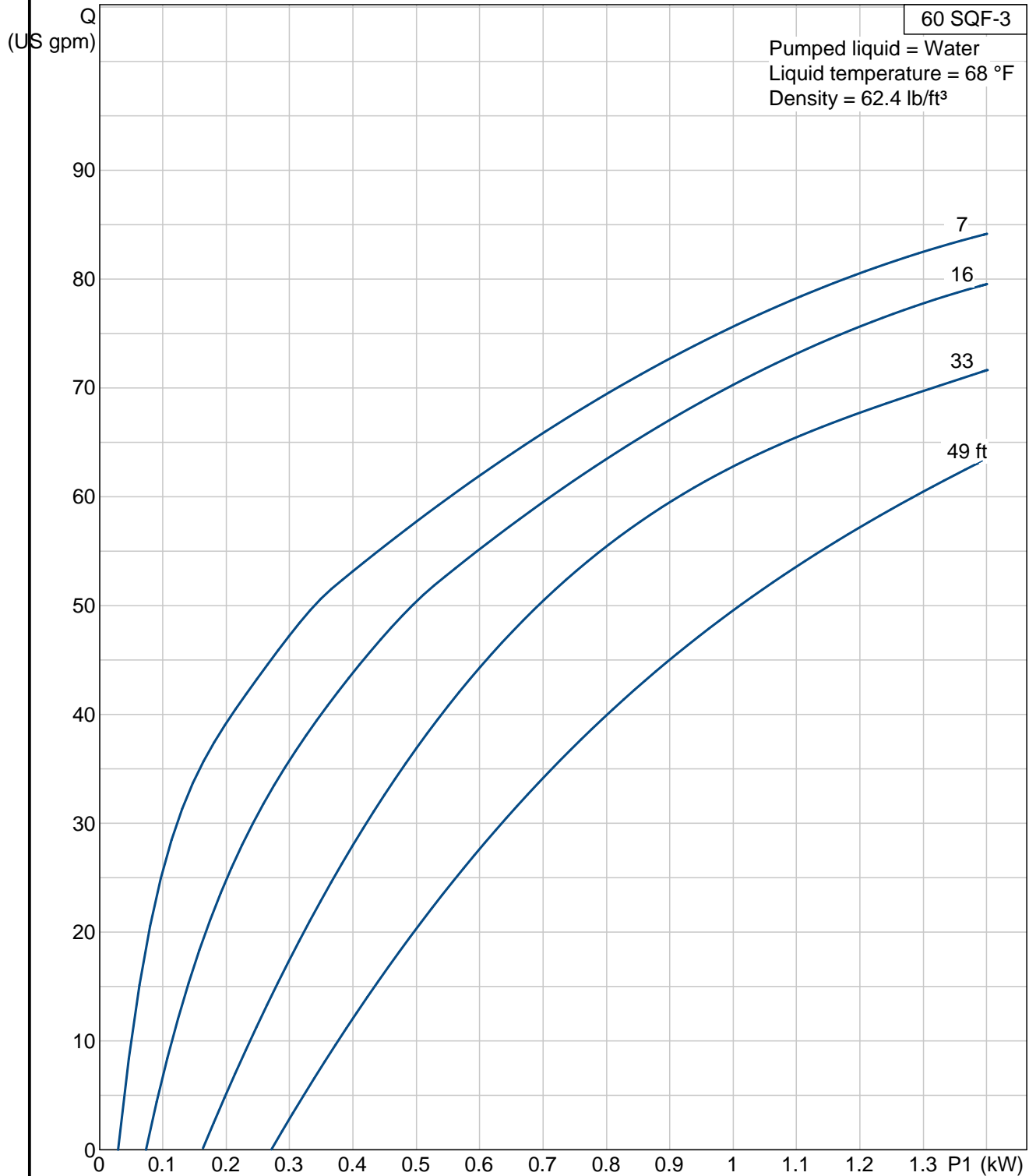

Description	Value
Product name:	60 SQF-3
Product No.:	95027443
EAN:	5700835026026
Technical:	
Approvals on motor nameplate:	CE
Pump Number:	95027447
Stages:	3
Valve:	pump with built-in non-return valve
Materials:	
Pump:	Stainless steel DIN W.-Nr. 1.4301 AISI 304
Impeller:	Stainless steel DIN W.-Nr. 1.4301 AISI 304
Rotor:	DIN W.-Nr. 1.4301 AISI 304
Stator:	DIN W.-Nr. 1.4301 AISI 304
Installation:	
Maximum ambient pressure:	218 psi
Pump outlet:	2 NPT"
Minimum borehole diameter:	4.02 in
Liquid:	
Maximum liquid temperature:	104 °F
Liquid temp:	68 °F
Density:	62.29 lb/ft³
Electrical data:	
Motor type:	MSF3
Power input - P1:	1.4 kW
Rated voltage AC:	1 x 90-240 V
Rated voltage DC:	30-300 V
Start. method:	direct-on-line
Rated current:	8.4 A
Power factor:	1
Rated speed:	500-3600 rpm
Enclosure class (IEC 34-5):	68
Insulation class (IEC 85):	F
Motor protection:	Y
Thermal protec:	internal
Length of cable:	6.562 ft
Motor Number:	96275336
Others:	
Net weight:	24 lb
Gross weight:	27.3 lb
Shipping volume:	1 ft³
Sales region:	N-amreg

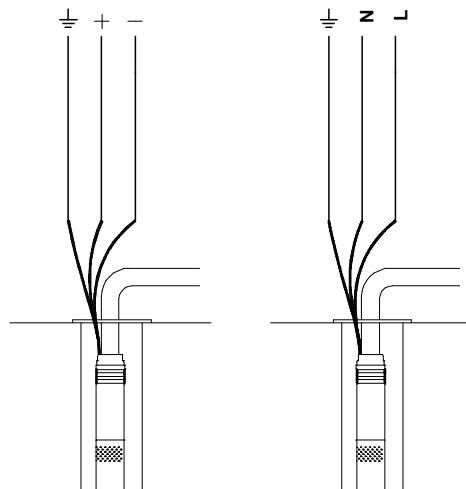
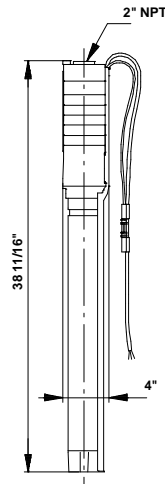
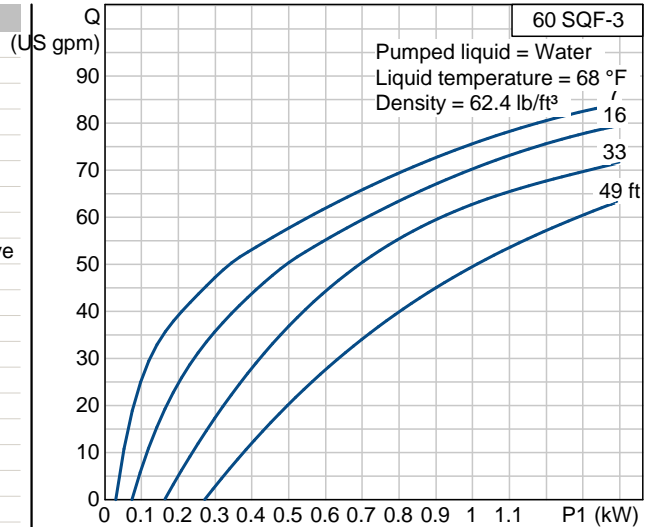

95027443 60 SQF-3 60 Hz

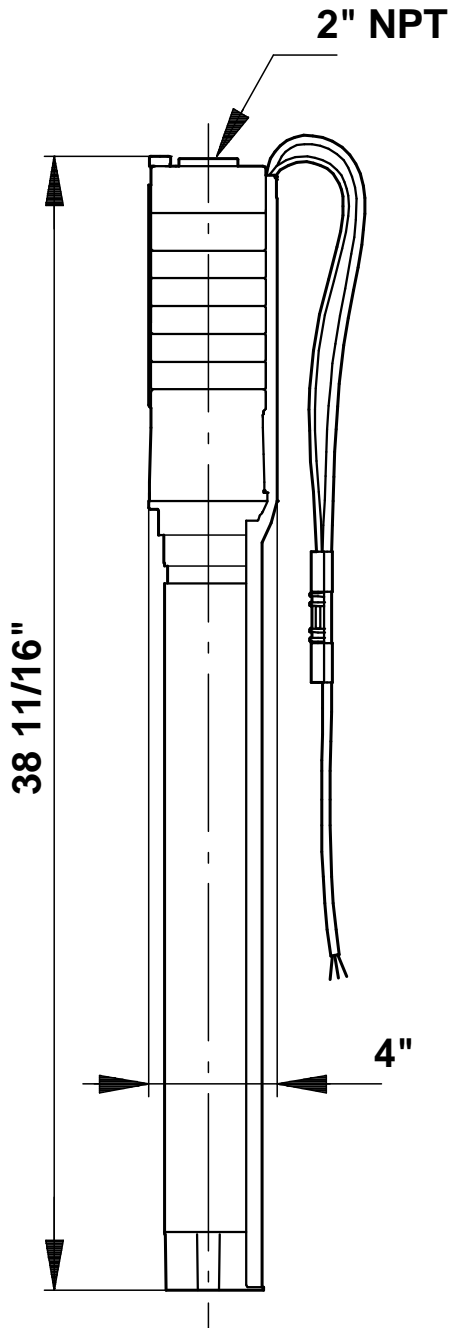

Note! All units are in [mm] unless others are stated.
Disclaimer: This simplified dimensional drawing does not show all details.

95027443 60 SQF-3 60 Hz

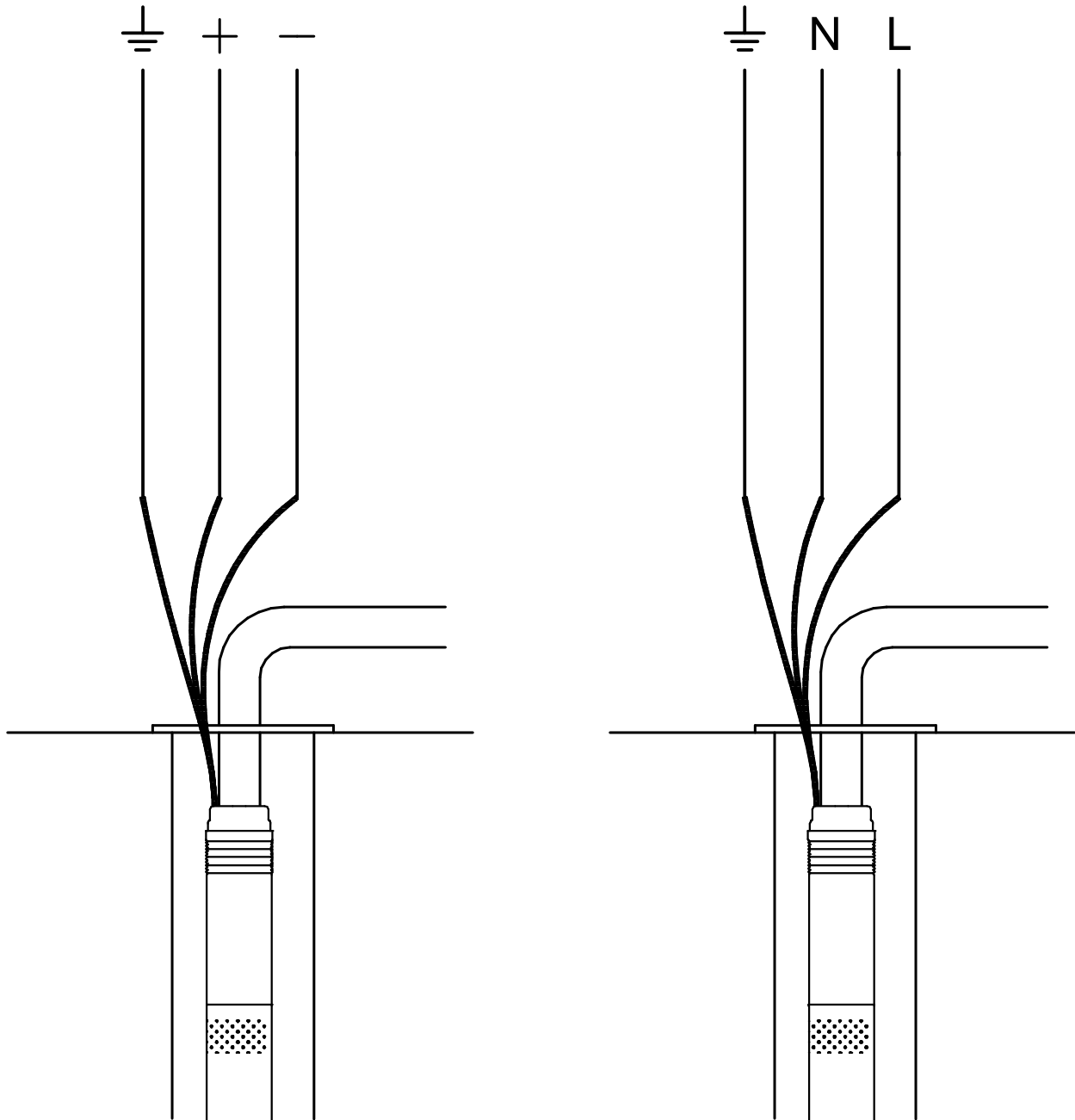

All units are [mm] unless otherwise presented.