

Position	Count	Description	Unit price
	1	<p><b>16 SQF-10</b></p>  <p>Product photo could vary from the actual product</p> <p>Product No.: 95027350</p> <p>The 4" SQF centrifugal pump is for low heads and large flows.</p> <p><b>Features and benefits:</b></p> <ul style="list-style-type: none"> <li>-Dry-running protection</li> <li>-High efficiency permanent-magnet motor (PM motor)</li> <li>-Over- and undervoltage protection</li> <li>-Overload protection</li> <li>-Maximum Power Point Tracking (MPPT)</li> <li>-Wide voltage range</li> </ul> <p><b>Liquid:</b></p> <p>Maximum liquid temperature: 104 °F            Liquid temp: 68 °F            Density: 62.29 lb/ft³</p> <p><b>Technical:</b></p> <p>Approvals on motor nameplate: CE</p> <p><b>Materials:</b></p> <p>Pump: Stainless steel            DIN W.-Nr. 1.4301            AISI 304</p> <p>Impeller: Stainless steel            DIN W.-Nr. 1.4301            AISI 304</p> <p><b>Installation:</b></p> <p>Maximum ambient pressure: 218 psi            Pump outlet: 1,25 NPT"            Minimum borehole diameter: 4.02 in            \:</p> <p><b>Electrical data:</b></p>	On request



**Company name:** Worldwide Power and Pump Services, Inc.

**Created by:** -

**Phone:** 866-960-9621

**Fax:** 866-960-9621

**Date:** 8-12-09

Position	Count	Description	Unit price
		Motor type: MSF3 Power input - P1: 1.4 kW Rated voltage AC: 1 x 90-240 V Rated voltage DC: 30-300 V Start. method: direct-on-line Rated current: 8.4 A Power factor: 1 Rated speed: 500-3600 rpm Enclosure class (IEC 34-5): 68 Insulation class (IEC 85): F Length of cable: 6.562 ft  <b>Others:</b> Net weight: 20.9 lb Gross weight: 24.3 lb Shipping volume: 1 ft <sup>3</sup>	



Company name: Worldwide Power and Pump Services, Inc.

Created by: -

Phone: 866-960-9621

Fax: 866-960-9621

Date: 8-12-09

95027350 16 SQF-10 60 Hz

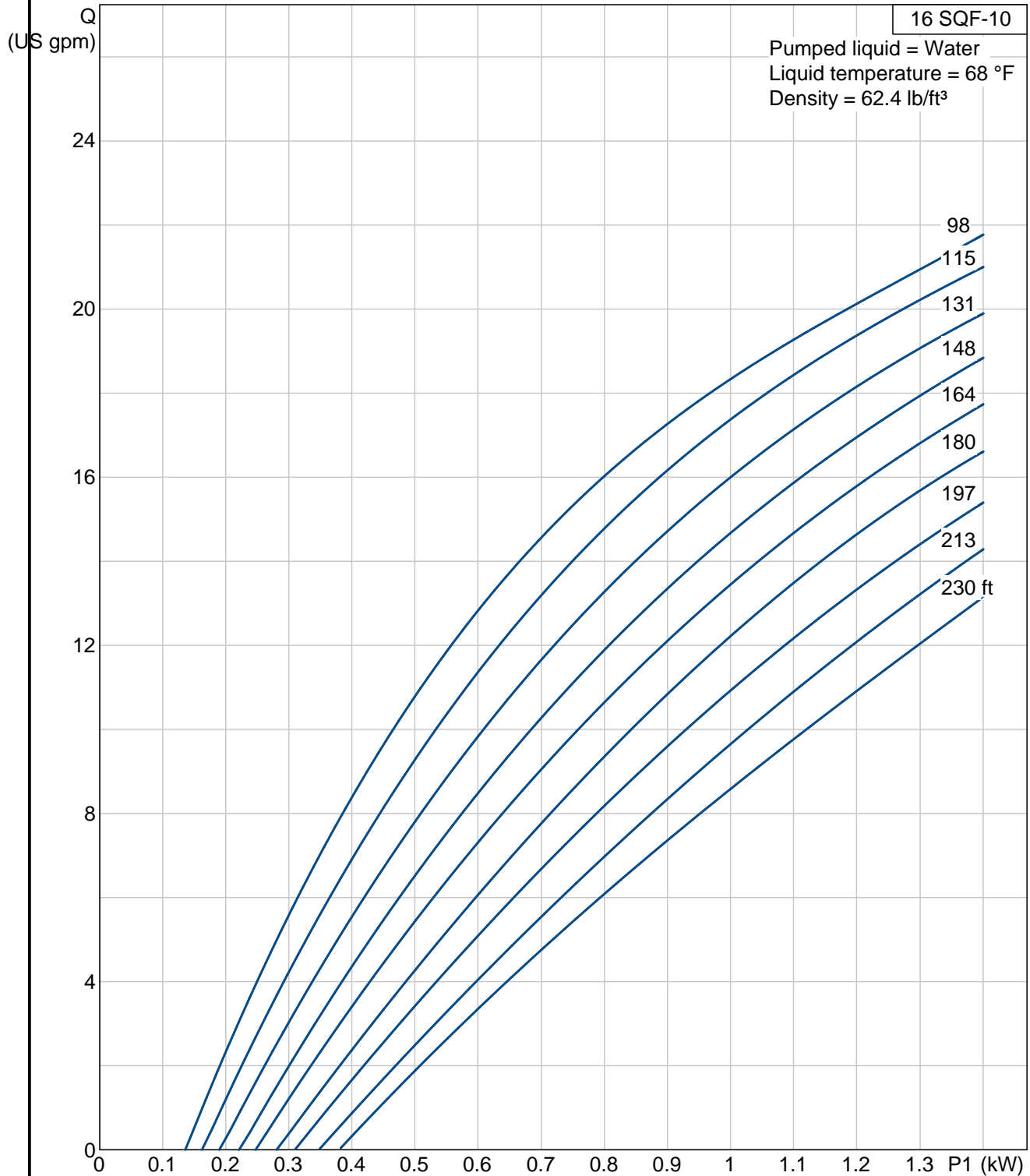

Description	Value
Product name:	16 SQF-10 (US gpm)
Product No.:	95027350
EAN:	5700834760457
<b>Technical:</b>	
Approvals on motor nameplate:	CE
Pump Number:	95027386
Stages:	10
Valve:	pump with built-in non-return valve
<b>Materials:</b>	
Pump:	Stainless steel DIN W.-Nr. 1.4301 AISI 304
Impeller:	Stainless steel DIN W.-Nr. 1.4301 AISI 304
Rotor:	DIN W.-Nr. 1.4301 AISI 304
Stator:	DIN W.-Nr. 1.4301 AISI 304
<b>Installation:</b>	
Maximum ambient pressure:	218 psi
Pump outlet:	1,25 NPT"
Minimum borehole diameter:	4.02 in
<b>Liquid:</b>	
Maximum liquid temperature:	104 °F
Liquid temp:	68 °F
Density:	62.29 lb/ft³
<b>Electrical data:</b>	
Motor type:	MSF3
Power input - P1:	1.4 kW
Rated voltage AC:	1 x 90-240 V
Rated voltage DC:	30-300 V
Start. method:	direct-on-line
Rated current:	8.4 A
Power factor:	1
Rated speed:	500-3600 rpm
Enclosure class (IEC 34-5):	68
Insulation class (IEC 85):	F
Motor protection:	Y
Thermal protec:	internal
Length of cable:	6.562 ft
Motor Number:	96275336
<b>Others:</b>	
Net weight:	20.9 lb
Gross weight:	24.3 lb
Shipping volume:	1 ft³
Sales region:	N-amreg

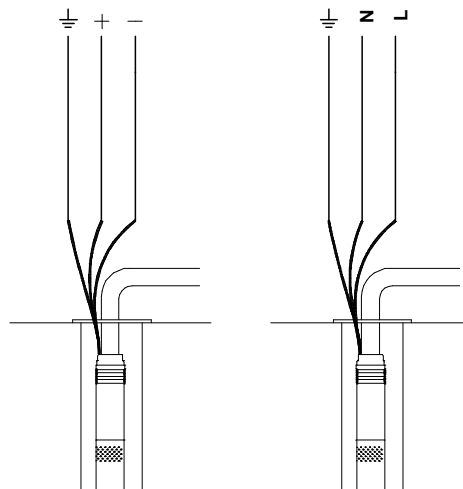
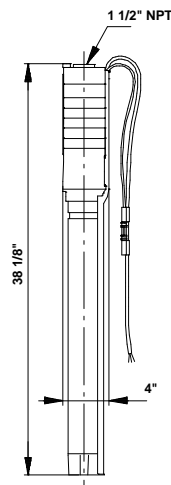
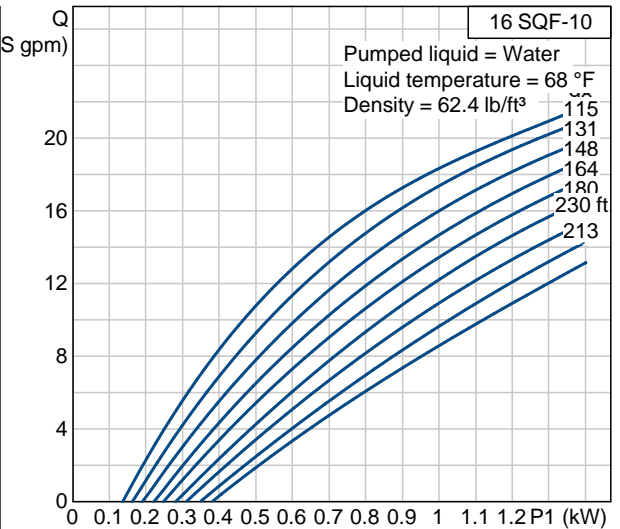

95027350 16 SQF-10 60 Hz

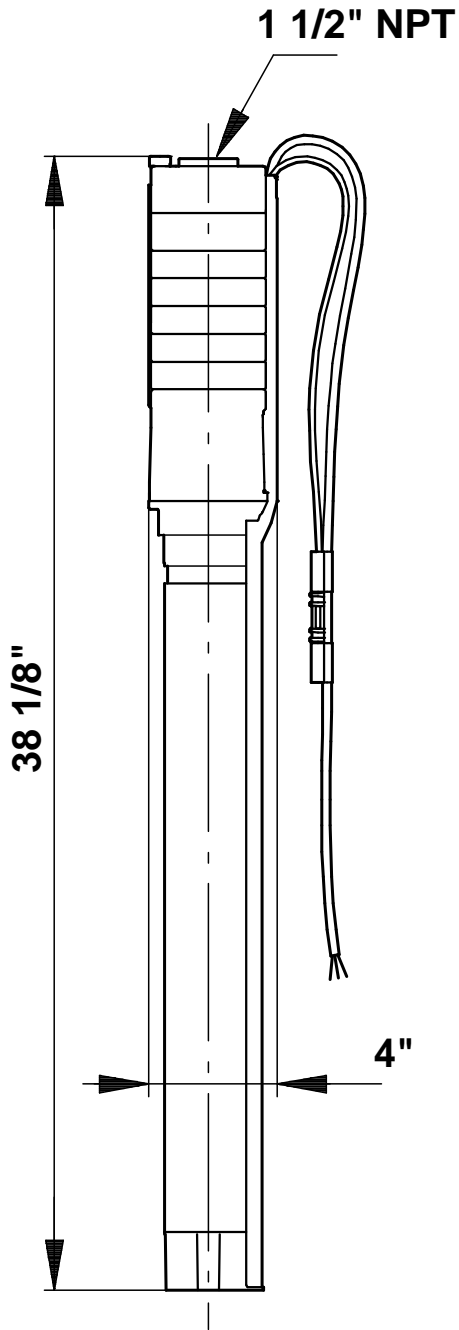

Note! All units are in [mm] unless others are stated.  
Disclaimer: This simplified dimensional drawing does not show all details.

**95027350 16 SQF-10 60 Hz**

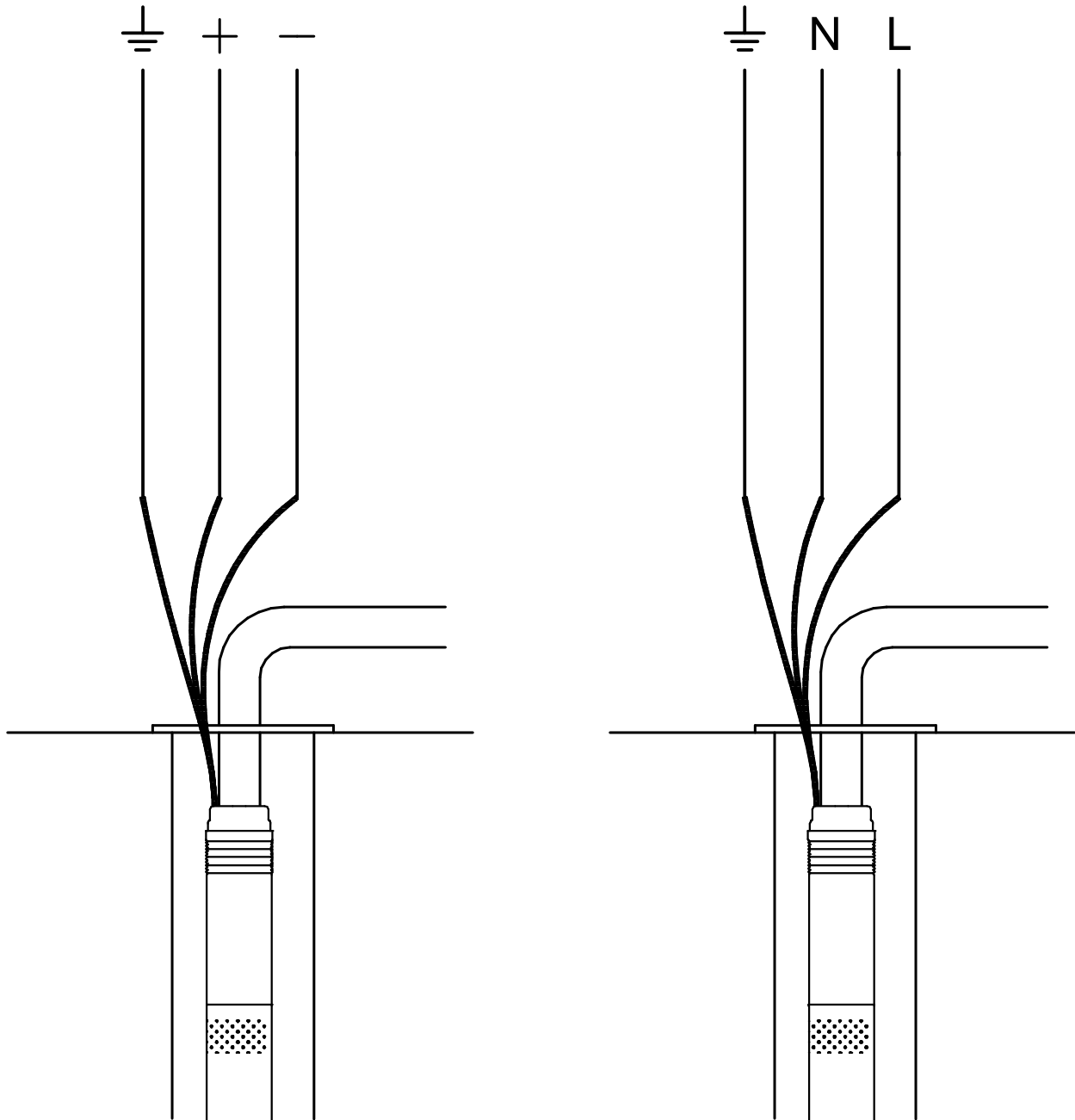

All units are [mm] unless otherwise presented.